

vtech®

Instruction Manual

# Kidizoom® Snap Touch



VTech understands that a child's needs and abilities change as they grow and with that in mind we develop our toys to teach and entertain at just the right level...

## vtech **Baby**

Toys that will stimulate their interest in different textures, sounds and colours

### I am...

...responding to colours, sounds and textures

...understanding cause and effect

...learning to touch, reach, grasp, sit-up, crawl and toddle

Birth-36 months



## Pre-School

Interactive toys to develop their imagination and encourage language development

### I want...

...to get ready for school by starting to learn the alphabet and counting

...my learning to be as fun, easy and exciting as can be

...to show my creativity with drawing and music so my whole brain develops

3-6 years



## Electronic Learning Computers

Cool, aspirational and inspiring computers for curriculum related learning

### I need...

...challenging activities that can keep pace with my growing mind

...intelligent technology that adapts to my level of learning

...National Curriculum based content to support what I'm learning at school

4-10 years



To learn more about this and other VTech® products, visit [www.vtech.co.uk](http://www.vtech.co.uk)

# INTRODUCTION

Enjoy endless fun with this compact device, jam-packed with apps and activities. Featuring a dual 5.0MP camera, games, fun photo and video filters, messaging, voice recording and more. You're bound to be the coolest kid in town with the **KidiZoom® Snap Touch!**

## INCLUDED IN THIS PACKAGE

- **KidiZoom® Snap Touch**
- Micro-USB cable
- Quick Start Guide

### **Note:**



The metallic coating on the **KidiZoom® Snap Touch** is insulating.

### **WARNING:**

All packing materials such as tape, plastic sheets, packaging locks, removable tags, cable ties, cords and packaging screws are not part of this toy and should be discarded for your child's safety.

**NOTE:** Please save this Instruction Manual as it contains important information.

**The battery in this product must not be disposed of with household waste. This battery is recyclable. Please follow your local recycling regulations.**

This toy is only to be connected to equipment bearing either of the following symbols:  or 

# PRODUCT FEATURES

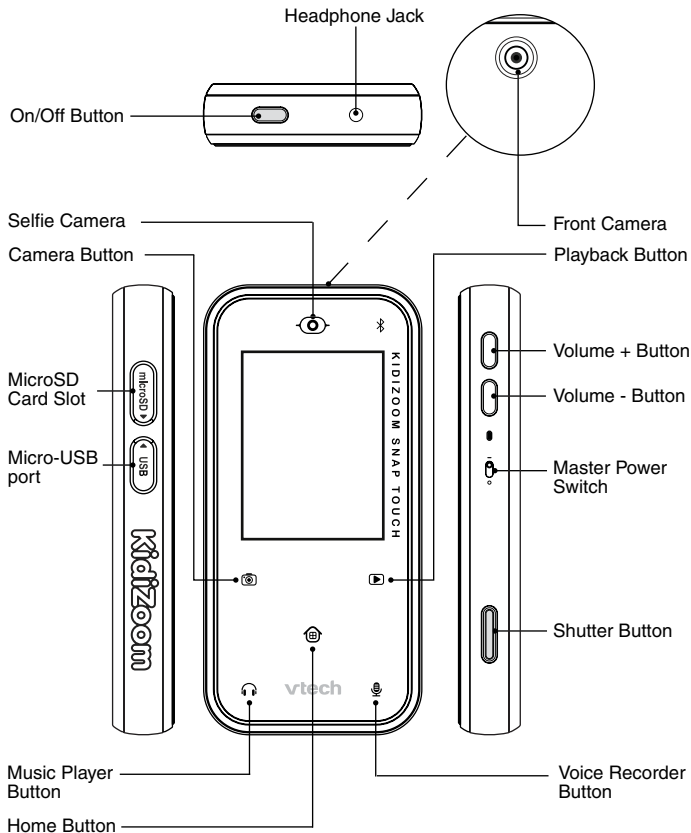

<b>Buttons</b>	<b>Description</b>
Master Power Switch	<p>Move the Master Power Switch to On before use and charge the battery.</p> <p>Note: It is not necessary to switch the device off in daily use. Once the Master Power Switch is Off, the device will stop functioning. After it is turned on again, the time and date will have to be reset.</p>
On/Off Button	Press this button to turn the device on or turn it off.
Shutter Button	Press this button to launch the camera and to take photos and videos.
Volume + Button	<p>Press this button to turn the volume up.</p> <p>In the Camera or Video screen, use this button to zoom in.</p>
Volume - Button	<p>Press this button to lower the volume.</p> <p>In the Camera or Video screen, use this button to zoom out.</p>
Home Button	<p>Tap this button to display the Home Menu to choose different activities.</p> <p>If you are in the apps screen, tap this button to go back to the previous screen.</p>
Camera Button	Tap this button to launch the camera and to take a photo.
Playback Button	Tap this button to view the taken photos and videos.
Music Player Button	Tap this button to go to the Music Player screen to listen to music (microSD card needed for storing MP3 files).

Voice Recorder Button	Tap this button to go to the Voice Recorder screen.
Micro-USB port	Connect to your computer with the included Micro-USB cable to transfer files and charge the device.
MicroSD Card Slot	Insert a microSD card here to expand the device's memory. (MicroSD card not included).
Headphone Jack	Insert headphones to output the device's sound through headphones.

## PRODUCT SPECIFICATIONS

Display	2.4" colour touch screen
Display Language	English (UK) French (FR)
Photo Resolution	5.0MP (1920 X 2560) – Extrapolation 2.0MP (1200 X 1600) 0.3MP (480 X 640)
Video Resolution	240 X 320
Video Length Limit Per File	5 mins per file (Internal memory) 10 mins per file (Memory card)
Focus Range	1.5 feet - ∞
Internal Memory	256 MB built-in memory (shared with program data; actual memory available for user storage will be less)
Memory Card Format and Capacity	microSD/microSDHC card (not included) with capacity from 1 GB to 32 GB Class 10 or above is recommended

File Format	Photo: Standard baseline JPG Video: AVI (Motion JPEG) Voice: Wave (22K16bit)
Connectivity	Use the Micro USB 2.0 cable (included) to connect to a computer for battery recharging and file transferring. Use <b>Bluetooth®</b> (BLE) to connect with another <b>KidiZoom® Snap Touch</b> to send messages, photos, voice clips and to play games.
Optimal Operating and Charging Temperature	32°F to 104°F (0°C to 40°C)

## STORAGE CAPACITY FOR REFERENCE



		5.0MP Photos	2.0MP Photos	0.3MP Photos	Videos (Minutes)	MP3 (assume 5MB each)
Internal Memory		140	160	800	5	NA
Micro SD Card	8 GB	10600	12700	65000	370	1638
	16 GB	21200	25400	130000	740	3276
	32 GB	42400	50800	260000	1480	6552

**Note:** The above amounts are approximations. The actual capacity depends on the shooting environment.

The video length limit per file is 10 minutes when using memory card.

File size limit is up to 2GB.

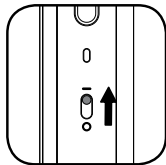

# GETTING STARTED

When you use the **KidiZoom® Snap Touch** for the first time, switch the Master Power Switch to the **On** position . When the Master Power Switch is in the **Off** position , it is not possible to charge the device or play any activities, and the system clock will be reset.





## BATTERY CHARGING

**Note:** Adult operation required.

- Make sure the device is not in use and the Master Power Switch is in the On position . Pull up the rubber cover over the Micro-USB Port on the side of device.
- Insert the Micro-USB Cable (small end) into the Micro-USB Port on the device.
- Insert the large end of the Micro-USB Cable into a USB port on a computer or USB port (Output DC 5V 1A) with Class II or III symbol  or .
- When the battery is charging, you will see the battery charging icon.
- When the battery is fully charged, the screen will turn off. Disconnect the device from the power source.

## CHARGING GUIDELINES

To charge the **KidiZoom® Snap Touch**, use the bundled micro-USB cable and connect it to a personal computer or USB port (Output DC 5V 1A) with the Class II or III symbol  or . Before use, inspect the cable to confirm that it is in good condition and that there are no breaks or exposed wires. Ensure there are no particles or liquid (water, juice, etc.) in either of the connectors before plugging in either end of the cable. The device should be completely dry with no debris in the cable connectors when charging. Plug in the cable securely, in the correct orientation. If the device is on when plugged in, a dialog box may open on your computer to allow you to access the device's drive. Never leave the device unattended while charging. Do not charge your device on soft surfaces, as they can trap heat around the device.



Examine the charging cord periodically for conditions that may result in the risk of fire, electric shock or injury due to damage to the cord, housing, or other parts. In the event of such conditions, the cord should not be used until properly repaired or replaced.



Typical charging time is between 4-4.5 hours if the battery is fully depleted. Disconnect the device when it is fully charged. Do not leave the device charging for more than 5 hours.

**Note:** The actual charging time depends on the charging current, the existing charge and the ambient temperature of the charging environment. The optimal ambient temperature is 32°F to 104°F (0°C to 40°C).

## WARNING MESSAGES

1	<p data-bbox="138 398 474 423">Master Power Switch Is Off</p> 	<p data-bbox="521 398 897 496">Slide the Master Power Switch to the On position  before charging the battery.</p>
2	<p data-bbox="138 679 470 704">Temperature Out of Range</p> 	<p data-bbox="521 679 871 777">The charging temperature range should be 32°F-104°F (0°C-40°C).</p>

## BATTERY LIFE

Like with other electronic devices, the more the device is used, the quicker the battery will drain. The battery will last approximately two hours with continuous use while taking photos and videos. With typical usage, the battery will last longer. The remaining battery capacity will display in the top right corner of the Home menu screen. When the battery level is low, recharge the battery before further use. When the battery level is too low, the device will not turn on until it is charged. If you find the time between charges is considerably shortened with no change in usage, the battery could be nearing the end of its life. The battery life varies from battery to battery depending on storage, operating conditions and environment.

## BATTERY MAINTENANCE

Charge the battery regularly to keep it operating at optimum performance, even when the device isn't regularly in use. For example, charge the device at least once every six months. Slide the Master Power Switch to the Off position  if the device will not be in use for an extended period of time.

**This toy contains batteries that are non-replaceable.**

### Australia/New Zealand

**WARNING! SAFETY INSTRUCTIONS, PLEASE READ THOROUGHLY BEFORE GIVING THIS PRODUCT TO A CHILD. KEEP AWAY FROM FIRE OR HEAT SOURCE. BATTERIES CANNOT BE REPLACED.**

The batteries within this toy are permanently encased. Before giving this toy to a child make sure there are no signs of damage. Regularly check the toy and dispose of it immediately if there are any signs of damage. Do not dispose of the toy in a fire, as the batteries may leak and explode. Keep batteries safely out of children's reach before disposing of them via a safe disposal system.

## DISPOSAL OF BATTERIES AND PRODUCT



The crossed-out wheelie bin symbols on products and batteries, or on their respective packaging, indicates they must not be disposed of in domestic waste as they contain substances that can be damaging to the environment and human health.

The chemical symbols Hg, Cd or Pb, where marked, indicate that the battery contains more than the specified value of mercury (Hg), cadmium (Cd) or lead (Pb) set out in the Batteries and Accumulators Regulation.



The solid bar indicates that the product was placed on the market after 13th August, 2005.

 Help protect the environment by disposing of your product or batteries responsibly.

### **VTech® cares for the planet.**

Care for the environment and give your toy a second life by disposing of it at a small electricals collection point so all its materials can be recycled.

## In the UK:

Visit [www.recyclenow.com](http://www.recyclenow.com) to see a list of collection points near you.

## In Australia & New Zealand:

Check with your local council for kerbside collections

# MEMORY CARD INSTALLATION

The **KidiZoom® Snap Touch** is compatible with microSD and microSDHC memory cards up to 32 GB. To install:

- Make sure the device is Off.
- Open the cover over the Memory Card Slot on the side of the device.
- Insert a memory card (not included) as illustrated. Once the memory card is detected, the memory card will automatically be used as the default memory.
- To remove the memory card from the device, push the card once and it will eject.

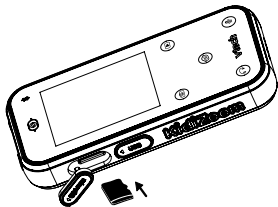

## Note

- **VTech®** recommends that you format your memory card before using it with the **KidiZoom® Snap Touch**.
- Data stored on the device's internal memory will not be accessible while the memory card is in use. Be sure to back up all data to a computer regularly to prevent loss of photos and videos.

# TO BEGIN USING KIDIZOOM® SNAP TOUCH

Make sure the Master Power Switch is set to the On position  and that the battery is fully charged before using it.

## Select a Language

The first time you turn On your **KidiZoom® Snap Touch**, press the On/Off Button.

The language selection screen will appear. Simply tap your preferred language, then tap the Tick icon .

## Set the Date and Time

Next, the date and time screens will display. Swipe up or down on the months, days, years, hours and minutes to set the correct date and time. Tap the Tick icon  when you have finished.

## To Begin Play

- Tap the Home Button to go to the Home Menu to access different activities.
- Press the Shutter Button or tap the Camera Button to go to the Camera screen to take photos.
- Tap the Playback Button to view the taken photos or videos.
- Tap the Music Player Button to go to the Music Player. (Store the MP3 in the MUSIC folder of the memory card) You can plug-in headphones to listen to music.
- Tap the Voice Recorder Button to voice record or check the recorded voice files.

## Automatic Screen Off

To preserve battery life, the screen will automatically shut off after a short period of time.

**Note:** The auto screen time can be adjusted in the Auto Screen Off in Settings. Please refer to the Settings section in this guide. For other activities, the device will exit to time screen automatically if there is no input for two minutes. In camera screen, games and Chat Room, auto exit time occurs after three minutes of inactivity.

## Connecting to a Computer

You can connect the **KidiZoom® Snap Touch** to a PC or Mac using the included Micro-USB Cable. To transfer files between your device and computer, follow these steps:

- Pull up the rubber cover of the Micro-USB Port on the side of your device.
- Insert the Micro-USB Cable (small end) into the Micro-USB Port on the device.
- Insert the larger end of the cable into a USB port on your computer.
- You will see a removable drive called **VTech® 5492**. If you are using a memory card, you will see the removable drive of your memory card, use this drive instead of **VTech® 5492**.

Please use this to transfer files to and from the device. There is another removable drive called VT SYSTEM, which is for storage of system data and should not be accessed by users.

**Note:** Once the device is connected to your computer, do not disconnect it while files are transferring. Only eject the device from your computer once it completes transferring files. Once ejected, you can then physically disconnect the device from your computer. Ensure the rubber cover over the micro-USB port is closed tightly.

**Note:** The USB mass storage mode can only be used when the device is unlocked. If the device is locked, the drive will not be shown.

### **To Back Up Photos or Videos:**

- From your computer, open the DCIM folder on the removable drive **VTech® 5492**.
- Copy and paste the photo and/or video files to a location on your computer.

### **To Back Up Recorded Sounds:**

- From your computer, open the VOICE folder on the removable drive **VTech® 5492**.
- Drag and drop the files to a location on your computer.

### **To Transfer MP3 files to the memory card to listen from KidiZoom® Snap Touch**

- First, select the MP3 files you would like to download from your computer.
- Locate and open the MUSIC folder on the removable drive of your memory card and drag and drop the MP3 files into this folder.

**NOTE:** The device does not read the MP3 files in the drive **VTech® 5492**, do not save the MP3 files to this drive as it will occupy your free memory.

### **To Transfer Photos or Videos to the device**

- First, select the photo or video files you would like to download from your computer.
- Locate and open the DOWNLOAD folder on the removable drive **VTech® 5492** and drag and drop the photo or video files into the PHOTO or VIDEO subfolders.

Note: Do not transfer photo or video files created by other cameras (except for **KidiZoom®** camera photo or video files) to **KidiZoom® Snap Touch**, as these files may not be compatible.

### **Minimum System Requirements**

Microsoft® Windows® 10 or above Operating System.

macOS 10.12 or above.

USB Port required.

Microsoft® and Windows logos are trademarks of Microsoft Corporation in the United States and other countries. Macintosh and Mac logos are trademarks of Apple Inc. in the United States and other countries. All other trademarks are the property of their respective owners.

### **Connecting to Headphones**

To output the device's sound via headphones, locate the headphone jack on top of the device, then insert a 3.5mm plug for your headphones (not included).

# ACTIVITIES

## Home Menu

Here you can access all apps in the device, see the battery status and current time.

- Tap the icon to enter this activity.
- Swipe left/right to scroll through different pages.
- The menu wallpaper can be set in Settings.

The icon's arrangement will be different if you turn some apps Off in the Apps Manager. The app icons will be arranged according to its index. The removed apps cannot be seen.

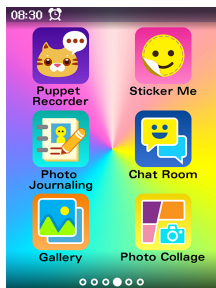
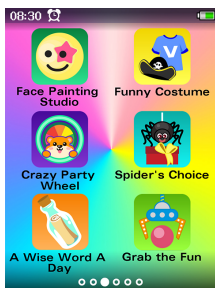
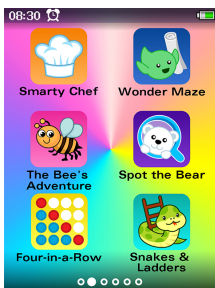
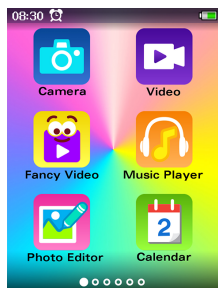

## Camera

Take photos with different camera effects, using the self-timer.

Tap  to switch between the back camera and selfie camera.

Tap  to display the Camera Effects menu.

Tap the left or right arrow icon to scroll through different photo effects.

Tap  to display the Self-Timer menu.

Press the volume + or volume – button to zoom in or out. The zoom status bar will appear while zooming.

Tap  or press the Shutter Button or Camera Button to take a photo.

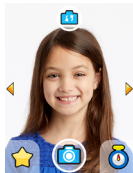

## Video

Take videos with the video effects and self-timer function.



Tap  to switch between the back camera and selfie camera.

Tap  to display the Video Effects menu.

Tap the left or right arrow icon to scroll through different video effects.

Tap  to display the self-timer menu.

Press the volume + or volume – button to zoom in or out. The zoom status bar will appear while zooming.

Tap  to start recording, tap  to stop recording.

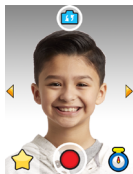

## Fancy Video

Take videos with different fun face-tracking stamps and effects using the back camera or selfie camera.

Tap  to switch between the back camera and selfie camera.

Tap the effect icon to start recording with your chosen effect. Tap  to stop recording.



## Music Player

Listen to MP3 files stored in your memory card.



Tap the song or folder to select.

Tap  to start playing.

Tap  to delete the selected song or folder.

Tap the up or down arrow or drag the circle on the bar to scroll through the list.

Tap  to pause the music.

Tap  or  to go to previous or next song.

Tap  to return to the Song list.

Tap  to select repeat mode, choose from repeat off, repeat song or repeat all.

Tap  to select shuffle mode; choose from shuffle on or shuffle off.

Note: You can use headphones to listen to Music (headphones not included).

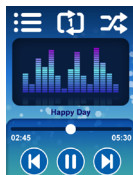
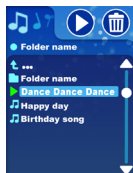

## Photo Editor

Edit photos by:

- Adding a photo frame
- Adding stamps (maximum 10)
- Adding text bubbles (maximum 5)
- Adding coloured filters
- Drawing on the photo

Tap an effect icon  to enter the Effects Sub-Menu.

For stamps and text bubbles, swipe left or right on the effects bar on the bottom to scroll through the options, tap one effect icon to make this appear on the photo. Drag and drop it to the position you want. To change the text in the bubble, tap the T icon and input the text with the on-screen keyboard. Tap the tick icon  when you are done.



For drawing, swipe left or right on the colour selection bar on the bottom to scroll through the colour pen options, tap a colour to select then draw on the photo.

Tap  to undo the last action. (Maximum 10 times of Undo)

Tap  to save the photo

In Effects Sub-menu, Tap  to confirm and go to Edit again for further editing.





## Calendar

See the days, weeks and months in the calendar.

Swipe left to see the next month.

Swipe right to see the previous month.

Swipe up to see the next year.

Swipe down to see the previous year.



## Smarty Chef

Swap the food ingredients to make 3-in-a-row to collect enough ingredients to make a dish!

Swap the food ingredients to move three or more of the same ingredients in a row. After ingredients are cleared, the ingredients at the top will drop down to refill the positions.



The score of the requested food ingredients will be recorded at the top right hand of the screen.

If enough food ingredients are collected, the level completes and goes to the Score screen. The remaining time will contribute towards the score. Therefore, the faster you get enough ingredients, the higher the score.







## Wonder Maze

The little explorer searches for the magic note to reveal the Wonderland's puzzle. Help him to collect enough magic notes, then find the crystal to enter the mystical path to the next place. Explore all the Wonderland places. Tap the position to move the character in order to collect objects and avoid obstacles.

Tap  or  to collect objects.



Tap the ladder  to go upstairs and downstairs.

Find the Maze Exit  to leave the maze after you have collected enough of the magic notes  and the magic crystals . Tap the Maze Exit to leave the maze .



## The Bee's Adventure

The little bee goes on an adventure to bring pollen back for his family!

Tap   to move left or right to collect the pollen and avoid the obstacles.

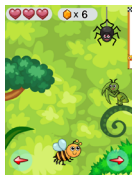

You have 3 lives, colliding with an obstacle will take away a life. If you collide with 3 obstacles you will lose the game. Collect the requested number of pollen to pass the level.



## Spot the Bear

The bear is hidden amongst the snowmen and other objects. Spot the bear to be rewarded points. You can connect with your friends to compete against them. Tap the hidden bear to gain points within the time limit. For Two-Player mode, select the two-player icon and then select the same room number to connect. The same pictures will be assigned to both players.



If the user quits the game, this will break the connection and end the game.

**Note:** Make sure the distance between the connecting devices is no more than 5 metres.



## Four-in-a-Row

Play Four-in-a-Row with the built in robot. Practise your logical thinking with AI or connect with a friend to play.

Tap the left or right arrow to move the disc to different columns.

Tap the disc to release it into the chosen column slot.

For single player mode, user and AI take turns.

For two-player mode, select the two-player icon and then select the same room number to connect, both users take turns to drop the disc.



If one player is idle for more than the time limit, the other player wins.

If a user quits the game, this will break the connection and end the game.

**Note:** Make sure the distance between the connecting devices is no more than 5 metres.



## Snakes & Ladders

Play with AI or a friend. Take turns to roll the dice and let the figures move, determined by the numbers thrown. When a figure reaches a place on the grid with a ladder, it will automatically climb to the top of the ladder. When it reaches a snakes head, it will automatically fall down to the snakes tail.

For single player mode, you will take turns with the AI to roll the dice and move.

For two-player mode, select the two-player icon and then select the same room number to connect, both users take turns to roll the dice and move.

The player who completes the grid first wins.

If a user quits the game, this will break the connection and end the game.

**Note:** Make sure the distance between the connecting devices is no more than 5 metres.

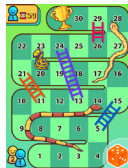

## Face Painting Studio

Add different face paint effects to your photos.

Align your face to take a photo and add different face painting effects.

Tap the effect icon     to enter the corresponding effects menu screen.

For the Paint Sponge, swipe left or right on the colour selection bar at the bottom to scroll through the colour options, tap a colour then tap on the face to use this colour. Tap the brush icon  to change to brush mode, draw on the face after selecting a colour.

For Stamps, Full Face Effects or Line Effects, swipe left or right on the effects bar at the bottom to scroll through the options, tap an effect icon to make it appear on the face. Drag and drop it to the position you would like.

Tap  to undo the last action.

Tap  to save the picture.





## Funny Costume

Mix and Match to create your own Funny Costume.

Store up to 50 funny designs.

Includes different hats, hairstyles, t-shirts, dresses, trousers, shorts, socks, shoes and different backgrounds.

Tap a type icon to edit the option of the clothing type.

Then tap the left or right arrow to scroll through the options.

Tap  to make a random outfit.

Tap  to save the creation.



## Crazy Party Wheel



Spin the wheel to win a prize! Record your own voice to announce the prize (2-8 prize slots).

In the Slot Edit Menu:

Tap the Add Slot Icon  to add more slots.

Tap the Minus icon  to remove that slot.

Tap the record button to record voice (<5 seconds) for that slot.

After the voice has been recorded, the record button will disappear. And there will be the play button  and delete voice button . Tap the Start button to go to the Spinning Screen to play!

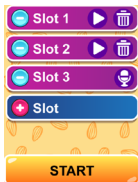

## Spider's Choice



Input a photo from the options (2-4 options), then spider's diagram will be generated. Choose a path, then the spider will retrieve it for you.

In the Present Edit Menu:

Tap the Add Slot Icon  to add more slots.

Tap the Minus icon  to remove that slot.

Tap the Camera icon to take a photo.

After the photo is taken, the view photo icon  and delete icon  will appear.



## A Wise Word A Day

Read a wise quote or word from the bottle from the sea everyday.

The obtained quotes will be stored in Collection.



## Grab the Fun

Operate the claw to grab a ball and solve a riddle. There are lots of funny riddles to explore. You will be granted 5 tokens every day.

Tap to insert a token to start the claw machine.

Tap to move the claw to the left.

Tap to move the claw to the right.

Tap to direct the claw down to pick up the ball.



## Puppet Recorder

Record a short voice (less than 15 seconds) with your selected puppet talking animation.

There are 8 character options and some of these will have voice changing effects.

Create up to 30 voice puppets. You can share them with your friends via the Chat Room.

Tap an expression icon to change the character's expression.

Tap to start the puppet recording.

When you have finished recording the voice, the puppet will repeat what you have said. Tap the left and right arrows to change the way the puppet moves.

Tap to replay the puppet recording.

Tap to confirm and save the puppet recording.

Tap to cancel the puppet recording.

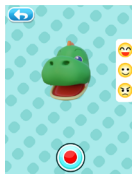

## Sticker Me

Create animated stickers with your face.

The fun stickers created can be shared with friends via the Chat Room.

Align and take a photo of your face or your friend's face.

Scroll through the sticker icons at the bottom of the screen to select different sticker options. Tap the icon to play with your captured face.

Tap to save the sticker.

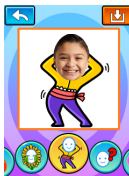



## Photo Journaling

Create your own photo journals.

Select your chosen template, then put your photos and text on the page to create a photo journal.



## Keyboard Screen

Tap the character to type on the output area.

Tap to select between uppercase and lowercase letters.

Tap to display the Numbers and Symbols keyboard.

Tap to clear the characters/symbols typed one by one, and hold this icon for 3 seconds to display the erase all typing confirmation. Tap Yes to erase all content.

Tap to display the Special Character keyboard.

Tap to display the Normal Character keyboard.

Tap to make a space.

Tap to go to the previous page or next page of the keyboard.

Tap to confirm the text and go to the next step of corresponding app. (In Chat Room, a send icon will replace the tick icon ).

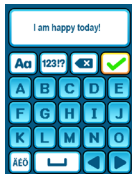

## Chat Room

Connect and chat with another **KidiZoom® Snap Touch** device.

Select the same room as your friend in the Chat Room app to connect with each other. When you're connected, you can share:

- Messages
- Emoticons
- Photos
- Voice Puppets
- Stickers

Tap the icons on the menu bar to go to the corresponding screen to select content to send.

Once a message is sent the message box will appear. Scroll up or down the screen to browse the chat history.

All the chat history will be cleared when you exit the current screen, including the photos, stickers and voice puppets received.

**NOTE:** Make sure the distance between the connecting devices is no more than 5 metres.

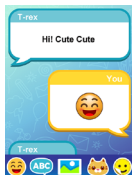
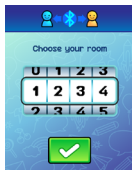



## Gallery

View the saved photos or videos in the internal memory or memory card (if a valid memory card has been inserted).

Tap the left or right arrow or scroll left or right to select the previous or next photo.

For video files, tap  to play.

Tap  to view the files in thumbnails.

Tap  to display the delete menu.

Tap  to rotate the photo 90° clockwise.

Press the volume +/- button to zoom in or out of the photo.

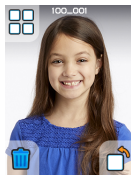

## Photo Collage

Take photos or choose photos to make a photo collage.

Choose different wallpapers to fit with your photos and themes.





## Alarm Clock

Set a morning wake up alarm to use everyday or for a one off alarm.

Scroll through the numbers to change the alarm time.

Tap the bell icon to set the alarm On .

Repeat , and alarm Off .

Tap the arrow icons to change the alarm ring tone.

Tap  to confirm the alarm change.

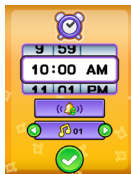

## Daily Reminders

Set reminders so you never forget a thing!

Create up to 40 daily reminders.

With 60+ event icons, you can take a photo or choose a photo as the event icon.

Tap the New Event icon  to add a new event.

Tap event icon to edit that event.

Tap the ring icon on each event to create a Reminder

(Remind everyday , Remind once ,

Reminder off )

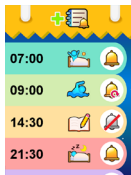



## Countdown Timer

Countdown the time within 99 minutes.

Scroll the number to select the countdown time.

Tap  to start the countdown timer.

Tap  to pause the countdown, then tap  to resume.

Tap  to prompt the dialogue box to reset the countdown.

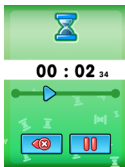

## Stopwatch

Count the time within 99 minutes.

Tap  to start running the stopwatch.

Tap  to stop the counting.

Tap  to lap the time. (Maximum of 10 laps will be displayed, the old ones will be replaced).

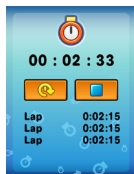



## Free Draw

Create your own drawings and save them as pictures, with 6 coloured pens and a rubber!

When in pen mode, draw on the screen.

Tap  to undo the last action (maximum undo 3 times).

Tap  to change to erase mode, draw on screen to erase the drawing.

Tap  to display the colour panel.

Tap  to save the drawing.



## Memos

Make up to 40 text memos.

Tap  New memo to create a new memo, go to the keyboard screen to type the text. When it is done, go back to this screen, the new memo will be shown.

Tap the memo,  will be shown, tap it to display the delete menu.



## Apps Manager

Manage apps or remove them from the home screen in Apps Manager.

Tap  to turn off the app, this will remove the app from the Home menu.

Tap  to turn on the app, this will reappear on the Home menu.

Only apps on page 2 and 3 can be managed.







## Voice Recorder

Record up to 5 minutes of your voice per file and edit your voice with fun voice changing effects.

Tap to record a new voice.

Tap the voice file on the list to select.

Tap to play the selected file. Tap to pause it while playing.

Tap to display the voice effect menu.

Tap to display the delete menu.

Tap to stop recording.

In the Voice Effect Menu:

Tap an effect icon to play the voice with that effect.

Tap the save icon to save the voice with the selected effect as another voice file.

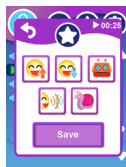
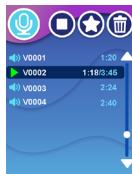

## Calculator

An on screen calculator for basic calculation.

Tap the number or symbol to input the amount for calculating, then tap = to see the answer.

Only 12 digits can be inputted or calculated.

Tap C to clear all.

Tap to erase the last inputted number.



## Roman Numeral Converter

Enter the Arabic number (1- 999) to convert to Roman Numerals.

Tap the number to input the Arabic number value, the Roman Numeral of the same value will be shown.

Tap to erase the last inputted number.

Tap ? to go to Roman Numeral Learning Screen.

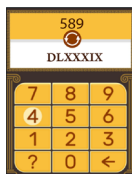

## Settings

To change the following settings for **KidiZoom® Snap Touch**.

Tap the icons on top to display corresponding setting screen.

### • Brightness

Tap to increase the brightness level.

Tap to decrease the brightness level.

## • Date & Time

Tap the set button to display the Set Date or Set Time Screen. Scroll up or down on the Days/Months/Years/Hours/Minutes to scroll through the numbers and set the date or time.

Tap the left or right arrow to change the date or time format.

When you have completed the setting, tap .

## • Wallpaper

Tap the left or right arrow to scroll through the different wallpapers.

Tap  to confirm the selection.

One option is to use a photo as the wallpaper.

## • Device Lock

The device allows you to set a face password or gesture password.

For setting a face password, you will need to follow the instructions on screen to make different facial expressions for the best recognition of your face.

For setting a gesture password, connect 5-9 dots on the screen to create the specific gesture password. You will need to re-enter the gesture to double confirm it.

Tap the left or right arrow to scroll through different options.

Tap  to confirm the selection.

Every time you enable the face lock or gesture lock, it will go to the password setting screen.

\*\*\*\*\***Forgot Password**\*\*\*\*\*

**In the Gesture Lock Screen, press + - + - within 5 seconds, to disable the lock.**

**Note:** The USB mass storage mode can only be used when the device is unlocked. If the device is locked, the drive will not be shown.

## • Memory

To see the free memory and select to format the memory.

## • Photo Resolution

Allow to select from 5.0MP (extrapolated), 2.0MP and 0.3MP. Tap the left and the right arrows to set the time, then tap the tick icon  to confirm. Choose a higher resolution for better photo quality, choose lower resolution to store more photos.

### • **Auto Screen Off**

Allows you to set an Auto Screen Off timer. Tap the left and the right arrows to set the time, then tap the tick icon  to confirm.

Tip: If the Auto Screen Off time is set to one of the longer options, battery consumption will increase and the time the battery lasts will decrease.

### • **Indoor Light Frequency**

The default frequency is set according to your region. Please leave your device set to the default value unless you are travelling.

### • **Device Name (for connection use)**

Set the device name to display when connecting with other **KidiZoom® Snap Touch**.

### • **Parental Controls (Game time limit/Connection On/Off)**

Follow the instructions to enter the Parental Control Settings to set the game time limit for each day and disable the connection function.

### • **Language**

Choose from a list of available languages to change the text interface of the device.

### • **Factory Reset**

Factory Reset will erase the content (including photos, videos and files) stored in the internal memory and reset all system settings to factory default, such as the file index, settings and game level. Files in the memory card (if used) will not be erased.

**Note:** When a memory card is inserted, data stored in the internal memory cannot be accessed on the device unless the memory card is removed. When the memory of the device is almost full, or when the file indexes are used up, back up all the files to your computer and then delete all the files on your device. To do this, either go to Settings and format the memory, or delete all photos and videos from Playback mode.

## WARNING

A very small percentage of the public, due to a pre-existing condition, may experience epileptic seizures or momentary loss of consciousness when viewing certain types of flashing colours or patterns. While the **KidiZoom® Snap Touch** does not contribute to any additional risks, we do recommend that parents supervise their children while they play games. If your child experiences dizziness, altered vision, disorientation, or convulsions, discontinue use immediately and consult your doctor. Please note that focusing on the **KidiZoom® Snap Touch** at close range and handling it as a game controller for a prolonged period of time may cause fatigue or discomfort. We recommend that children take a 15-minute break for every hour of play.



High sound pressure

Hearing damage risk

Do not listen at high volume levels for long periods

## CARE & MAINTENANCE

- Keep the rubber cover of the Micro-USB Port and Memory Card Slot tightly closed while the device is not in use in order to prevent dust or water from getting into it.
- Keep the device clean by wiping it with a slightly damp cloth.
- Turn the device off at the Master Power Switch if it will not be in use for an extended period of time.
- Keep the device out of direct sunlight and away from any direct heat source.
- Do not drop the device on a hard surface and do not expose it to moisture or immerse it in water.
- Keep the Lens clean. If the images are blurry, it could be because there is dust or dirt on the Lens.

# TROUBLESHOOTING

Consult this section if you experience difficulty while operating your **KidiZoom® Snap Touch**.

Problem	Solution
The device isn't working	<ol style="list-style-type: none"><li>1. Turn the <b>Master Power Switch</b> off for 30 seconds.</li><li>2. Turn the <b>Master Power Switch</b> on again and then press the <b>On/Off</b> button to turn it on. The device should now work properly.</li><li>3. If the device still doesn't work, recharge the battery and try again.</li></ol>
Abnormal Screen Display	<ol style="list-style-type: none"><li>1. Turn the <b>Master Power Switch</b> off for 30 seconds.</li><li>2. Turn the <b>Master Power Switch</b> on again and then press the <b>On/Off</b> button to turn it on. The screen should now work properly.</li></ol>
Unclear Photos and Videos	<ol style="list-style-type: none"><li>1. Make sure the lighting conditions of the shooting environment are adequate.</li><li>2. Check to see if the <b>Lens</b> is clear.</li></ol>

<p>Unstable Video Recording</p>	<ul style="list-style-type: none"> <li>• Check your memory card's performance. We recommend using a Class 10 or above microSD/microSDHC card. Using a memory card with lower performance may slow the video data writing on the card and thus affect the video quality.</li> <li>• The performance of some memory cards will slow down after they have been used for a long time. If you have this problem, first back up your files and then reformat the card.</li> </ul>
<p>Unable to Connect to Computer</p>	<ul style="list-style-type: none"> <li>• Check the connections on the USB cable between the device and the computer and review the connection procedures in this manual.</li> <li>• Turn the <b>Master Power Switch</b> off for 30 seconds. Turn the <b>Master Power Switch</b> on and connect to the computer again.</li> </ul>
<p>Flickering Video Recording</p>	<ul style="list-style-type: none"> <li>• Check if the Indoor Light Frequency setting is correct.</li> <li>• Avoid having both sunlight and indoor lighting appear at the same time in your video composition.</li> </ul>

<p>Unable to Connect to Another <b>KidiZoom® Snap Touch</b></p>	<ul style="list-style-type: none"><li>• Make sure you and your friend are choosing the same activity and select the same room number for connecting.</li><li>• Don't be too far away from your friend, keep the distance not more than 5 metres between each other.</li></ul>
<p>Undetected Memory Card</p>	<ul style="list-style-type: none"><li>• Check if the memory card is correctly inserted.</li><li>• Check to see if the memory card is the supported type. The device only supports microSD or microSDHC card.</li><li>• Check to see if the file system of your memory card is FAT or FAT32. The device does not support NTFS or exFAT file systems. Be sure to back up all important data from your memory card and format it in either the FAT or FAT32 file system before using in your <b>KidiZoom® Snap Touch</b>.</li></ul>

Unable to View Downloaded  
Video and Photo Files

1. Check if the downloaded files are in the correct directory on the **KidiZoom® Snap Touch** Photos should be put in the DOWNLOAD/PHOTO folder, and videos should be put in the DOWNLOAD/VIDEO folder.
2. **KidiZoom® Snap Touch** only supports these formats:
3. Photos in Standard Baseline JPEG, and videos in AVI (Motion JPEG)

## DECLARATION OF CONFORMITY

Hereby, **VTech®** Electronics Europe BV declares that the radio equipment type 5492 is in compliance with Directive 2014/53/EU. The full text of the EU declaration of conformity is available at the following internet address:

[www.vtech.com/re-directive](http://www.vtech.com/re-directive)

Frequency Band: 2400MHz – 2483.5MHz

Maximum RF power: 0.0010 W (0 dBm)

## DECLARATION OF CONFORMITY

Hereby, **VTech®** Electronics Europe Plc declares that the radio equipment type 5492 is in compliance with The Radio Equipment Regulations 2017 (2017 No.1206). The full text of the Declaration of conformity is available at the following internet address:

[www.vtech.com/re-directive](http://www.vtech.com/re-directive)

Frequency Band: 2400MHz – 2483.5MHz

Maximum RF power: 0.0010 W (0 dBm)



# CONSUMER SERVICES

Creating and developing **VTech®** products is accompanied by a responsibility that we at **VTech®** take very seriously. We make every effort to ensure the accuracy of the information, which forms the value of our products. However, errors sometimes can occur. It is important for you to know that we stand behind our products and encourage you to call our Consumer Services Department with any problems and/or suggestions that you might have. A service representative will be happy to help you.

## **UK Customers:**

Phone: 0330 678 0149 (from UK) or +44 330 678 0149 (outside UK)

Website: [www.vtech.co.uk/support](http://www.vtech.co.uk/support)

## **Australian Customers:**

Phone: 1800 862 155

Website: [support.vtech.com.au](http://support.vtech.com.au)

## **NZ Customers:**

Phone: 0800 400 785

Website: [support.vtech.com.au](http://support.vtech.com.au)

# PRODUCT WARRANTY/ CONSUMER GUARANTEES

## **UK Customers:**

Read our complete warranty policy online at [vtech.co.uk/warranty](http://vtech.co.uk/warranty).

## **Australian Customers:**

**VTECH ELECTRONICS (AUSTRALIA) PTY LIMITED – CONSUMER GUARANTEES**

Under the Australian Consumer Law, a number of consumer guarantees apply to goods and services supplied by VTech Electronics (Australia) Pty Limited. Please refer to [vtech.com.au/consumerguarantees](http://vtech.com.au/consumerguarantees) for further information.

The *Bluetooth®* word mark and logos are registered trademarks owned by the Bluetooth SIG, Inc. and any use of such marks by [licensee name] is under license. Other trademarks and trade names are those of their respective owners.

**Visit our website for more  
information about our products,  
downloads, resources and more.**

***www.vtech.co.uk***  
***www.vtech.com.au***

